

**TOOLS ENGINEERED TO PERFORM**

---



**Table of Contents**

**Pages**

<b>Microstop Countersink Cages and Cutters.....</b>	<b>1 - 21</b>
<b>Temporary Fasteners.....</b>	<b>22 - 23</b>
<b>New Products.....</b>	<b>24 - 26</b>



**MARTIN MM-303-HS  
MICRO STOP COUNTERSINKING UNIT**

**NEW!**

**MM-303-HS...Rated at 5000 RPM**



A precision tool equipped with full ball bearing for thrust and roller bearing for spindle support at 5000 RPM.

This unit is an improved design of an already proven tool. Design change allows for a better use of carbide and diamond countersink cutters to cut exotic materials. Positive locking in increments of .001 by hand adjustment plus a locking ring eliminates any possibility of an adjustment change when in use.

Unit takes 1/4"-28 threaded shank cutters up to and including 5/8" diameter. Available with 6 millimeter threaded spindle on request.

**MM-303-HS-1**  
(Shown)

**Designed to operate at 5000 maximum RPM.**

MM-303-HS Stop Countersinking Units may be ordered with various skirts as indicated below by using the part numbers shown when ordering. These are standard skirts as our MM-303 Series

**MM-303-2 Closed**  
Max Cutter Diameter 3/4"



**MM-303-3**  
2 Open Sides



**MM-303-5B**  
Hardened Steel Foot



**MM-303-4**  
1 Open Side



**MM-303-6**  
2 Open Sides  
Cutter Diameter 3/8"



**MM-303-5A**  
Nylon Foot



**MM-303-9**  
Olympic-Type  
Bulb Fastener



# MARTIN MM-303 MICRO STOP COUNTERSINKING UNIT

## MM-303 Micro Stop Countersinking Unit

A precision tool equipped with full ball bearing for thrust with an oilite radial bearing. This unit is an improved design of an already proven tool. Design change has reduced the number of parts and allows easy takedown for cleaning and maintenance. Positive locking in increments of .001 by hand adjustment plus a locking ring eliminates any possibility of an adjustment change when in use. Unit takes 1/4"-28 threaded shank cutters up to and including 5/8" diameter. Available with 6 millimeter threaded spindle on request.

**Designed to operate at 3000 maximum RPM.**

MM-303 Stop Countersinking Units may be ordered with various skirts as indicated below by using the part numbers shown when ordering.



# MARTIN MM-303-M/303-J/303-SJ MICRO STOP COUNTERSINKING UNITS

## MM-303-M Stop Countersinking Unit

A medium heavy unit with the same basic design as the MM-303. Micrometer adjustment in increments of .001 with positive locking. This unit takes standard 3/8"-24 threaded shank cutters with a maximum capacity of 7/8" diameter. Available with 8 millimeter threaded spindle on request.

**Operating speed 3,000 RPM max.**



## MM-303-J

Same as MM-303-M with 3/8"-24 spindle. This unit has a cutter capacity of 1 1/4" diameter. Available with 8 millimeter threaded spindle on request.

**Operating speed 3,000 RPM max.**



## MM-303-SJ Micro Stop Countersinking Unit

An extra heavy duty unit with heavier construction and a larger cutter capacity than the MM-303-J. Micrometer adjustment in increments of .001 with positive locking. This unit takes 7/16"-20 threaded shank cutters with a maximum cutter capacity of 1 1/2" diameter. Available with 10 millimeter threaded spindle on request.

**Operating speed 3,000 RPM max.**



OTHER SIZES AVAILABLE ON REQUEST

# CUTTING TOOLS MM-303-EXFT

## Extended Footpiece Type

**MM-303 EXFT** micro-stop has the basic design and adjustments of Martin's standard MM-303 series. Extended length foot piece and reduced diameters are designed to get to hard to reach areas. Use the standard 1/4-28 threaded cutters.

Model Number	Cutter Thread	Max. Cutter Dia.	B	C
MM-303-EXFT-1	10-32	250	275	375
MM-303-EXFT-2	1/4-28	300	325	425
MM-303-EXFT-3	1/4-28	375	400	500
MM-303-EXFT-4	1/4-28	562	656	750

**MIDGET MODEL**  
For close quarter operation

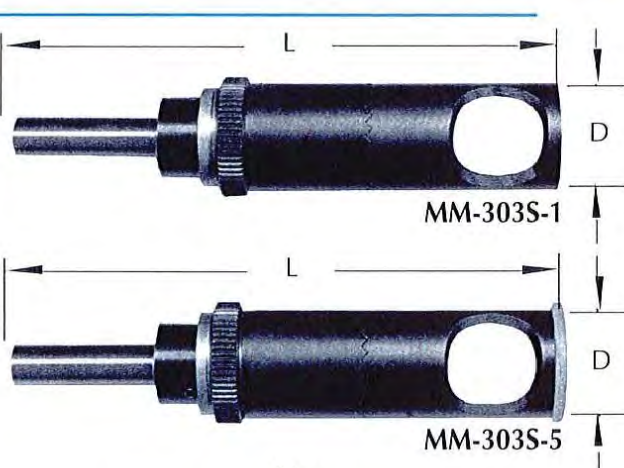

Model Number	Cutter Thread	Max. Cutter Dia.	D	L
MM-303S-1	1/4-28	7/16"	11/16"	3 3/16"
MM-303S-5	1/4-28	3/8"	11/16"	3 3/16"

MM-303S-5 has nylon insert on footpiece



# MARTIN MM-305 INTEGRAL PILOT COUNTERSINKS

MM-305 Integral Pilot Countersinks are stocked in 82° and 100°. For stock pilot diameters, see "Martin Standard Pilot Sizes" page. Martin Aircraft Tool Company also manufactures 6, 8 and 10 millimeter threaded shank cutters and special millimeter pilot diameters on request.

Tool Number	D-Diameter	Shank
MM-305-0	5/16"	1/4"-28
MM-305-1	3/8"	1/4"-28
MM-305-2	7/16"	1/4"-28
MM-305-3	1/2"	1/4"-28
MM-305-4	5/8"	1/4"-28
MM-305-5	3/4"	3/8"-24
MM-305-6	7/8"	3/8"-24
MM-305-7	1"	3/8"-24
MM-305-8	1 1/8"	3/8"-24
MM-305-9	1 1/4"	3/8"-24
MM-305-10	3/4"	7/16"-20
MM-305-11	7/8"	7/16"-20
MM-305-12	1"	7/16"-20
MM-305-13	1 1/8"	7/16"-20
MM-305-14	1 1/4"	7/16"-20
MM-305-15	1 3/8"	7/16"-20
MM-305-16	1 1/2"	7/16"-20

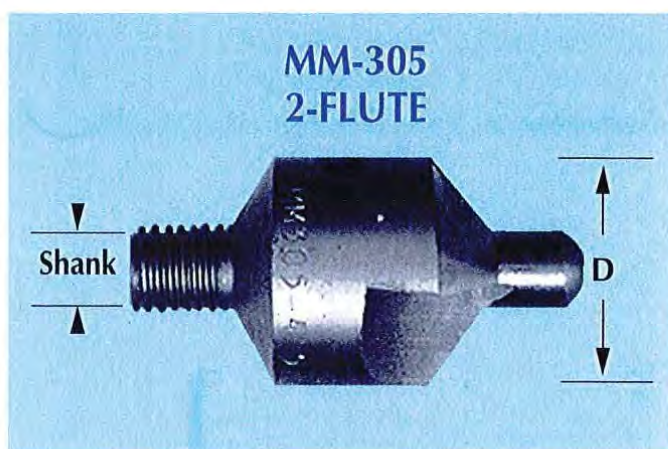

When ordering please specify angle and pilot diameter, and indicate MM-305 for 2-flute, or MM-305A for 3-flute.

# MARTIN STANDARD PILOT SIZES

The following list applies to Integral Pilot Countersink Cutters, illustrating standard cutters carried in stock with pilot sizes indicated. Other pilot diameters are available. Price will be quoted.

Cutter Body	Cutter Thread Size	3/32"	#40	1/8"	#30	5/32"	#21	3/16"	#10	7/32"	1/4"	F	5/16"	3/8"	7/16"	1/2"
1/4"	1/4"-28	X	X	X	X											
5/16"	1/4"-28	X	X	X	X	X	X									
3/8"	1/4"-28	X	X	X	X	X	X	X	X							
7/16"	1/4"-28	X	X	X	X	X	X	X	X							
1/2"	1/4"-28	X	X	X	X	X	X	X	X	X	X	X				
5/8"	1/4"-28			X	X	X	X	X	X	X	X	X	X			
3/4"	3/8"-24							X	X	X	X	X	X	X		
7/8"	3/8"-24									X	X	X	X	X	X	
1"	3/8"-24									X	X	X	X	X	X	X
1 1/8"	3/8"-24										X	X	X	X	X	X
1 1/4"	3/8"-24										X	X	X	X	X	X
1 3/8"	3/8"-24										X	X	X	X	X	X
7/8"	7/16"-20									X	X	X	X	X	X	
1"	7/16"-20									X	X	X	X	X	X	X
1 1/8"	7/16"-20										X	X	X	X	X	X
1 1/4"	7/16"-20										X	X	X	X	X	X
1 3/8"	7/16"-20												X	X	X	X
1 1/2"	7/16"-20												X	X	X	X

# MARTIN MM-307 REPLACEABLE PILOT COUNTERSINKS



## MM-307 3 Flute Replaceable Pilot

2 Flute Available on Special Order

Designed primarily for use in countersinking units. These cutters are made from the finest high speed tool steel, precision ground to maintain concentricity and radial clearance which will assure fast and smooth cutting. Available in 6, 8 or 10 millimeter threaded shank on request.



## MM-311 Countersink Pilots

Replaceable countersink pilots are made of tool steel, heat treated and ground to close limits. Undercut head seats on the cutter angle, reducing breakage. For use with replaceable countersink cutters.

Tool Number	D-Dia.	Shank	Pilot Hole
MM-307-0	5/16"	1/4"-28	.086
MM-307-1	3/8"	1/4"-28	.086
MM-307-2	7/16"	1/4"-28	.086
MM-307-3	1/2"	1/4"-28	.086
MM-307-4	5/8"	1/4"-28	.086
MM-307-5	3/4"	3/8"-24	.170
MM-307-6	7/8"	3/8"-24	.170
MM-307-7	1"	3/8"-24	.170
MM-307-8	1 1/8"	3/8"-24	.170
MM-307-9	1 1/4"	3/8"-24	.170
MM-307-10	3/4"	7/16"-20	.170
MM-307-11	7/8"	7/16"-20	.170
MM-307-12	1"	7/16"-20	.170
MM-307-13	1 1/8"	7/16"-20	.170
MM-307-14	1 1/4"	7/16"-20	.170
MM-307-15	1 3/8"	7/16"-20	.170
MM-307-16	1 1/2"	7/16"-20	.170

Stocked in 82° and 100° angles.  
When ordering please specify angle.



# MARTIN MM-308 REPLACEABLE PILOT COUNTERSINKS



**MM-308 3 Flute Replaceable Pilot**  
2 Flute Available on Special Order

Designed primarily for use in countersinking units. These cutters are made from the finest high speed tool steel, precision ground to maintain concentricity and radial clearance which will assure fast and smooth cutting. Available in 6, 8 or 10 millimeter threaded shank on request.



**MM-311 Countersink Pilots**

Replaceable countersink pilots are made of tool steel, heat treated and ground to close limits. Undercut head seats on the cutter angle, reducing breakage. For use with replaceable countersink cutters.

Tool Number	D-Dia.	Shank	Pilot Hole
MM-308-0	5/16"	1/4"-28	5/64"
MM-308-1	3/8"	1/4"-28	5/64"
MM-308-2	7/16"	1/4"-28	5/64"
MM-308-3	1/2"	1/4"-28	5/64"
MM-308-3B	1/2"	1/4"-28	1/8"
MM-308-4	5/8"	1/4"-28	1/8"
MM-308-5	3/4"	3/8"-24	3/16"
MM-308-6	7/8"	3/8"-24	3/16"
MM-308-7	1"	3/8"-24	3/16"
MM-308-8	1 1/8"	3/8"-24	3/16"
MM-308-9	1 1/4"	3/8"-24	3/16"
MM-308-10	3/4"	7/16"-20	3/16"
MM-308-11	7/8"	7/16"-20	3/16"
MM-308-12	1"	7/16"-20	3/16"
MM-308-13	1 1/8"	7/16"-20	3/16"
MM-308-14	1 1/4"	7/16"-20	3/16"
MM-308-15	1 3/8"	7/16"-20	3/16"
MM-308-16	1 1/2"	7/16"-20	3/16"

**Stocked in 82° and 100° angles.  
When ordering please specify angle.**

# MARTIN MM-311 REPLACEABLE COUNTERSINK PILOTS

## MM-311 Replaceable Countersink Pilot



**MM-311 Replaceable Countersink Pilots** are made of tool steel, heat treated and ground to close limits. Undercut head seats on the cutter angle, reducing breakage.

For use with replaceable countersink cutters.

Standard Pilot sizes listed below.  
To be used with MM-307, MM-308, MM-314, MM-324 and MM-701 Series

Pilot Number	S	D
MM-311-1	.086	SPECIFY
MM-311-2	.170	
MM-311-3	5/64"	
MM-311-4	3/32"	
MM-311-5	1/8"	
MM-311-6	3/16"	

Pilot Diameter	Shank Diameter					
	5/64"	.086	3/32"	1/8"	.170	3/16"
5/64"	X					
.086	X	X				
3/32"	X	X	X			
#40	X	X	X			
1/8"	X	X	X	X		
#30	X	X	X	X		
5/32"	X	X	X	X		
#20	X	X	X	X		
.170	X	X	X	X	X	
3/16"	X	X	X	X	X	X
#10	X	X	X	X	X	X
7/32"	X	X	X	X	X	X
1/4"	X	X	X	X	X	X
F	X	X	X	X	X	X
5/16"				X	X	X
3/8"				X	X	X
7/16"					X	X
1/2"					X	X
5/8"						X

OTHER SIZES AVAILABLE ON REQUEST

# MARTIN MM-312/312B STRAIGHT FLUTED COUNTERSINKS



## Martin MM-312 Straight Fluted Countersinks

MM-312 Straight Fluted Countersinks are precision machined from high speed steel and have three flutes designed for fast chip removal. The cutting edges of Martin Countersinks are relieved radially for fast, free cutting and longer tool life.

These countersinks are adaptable to lathe, drill press, and general mill work.

Standard included in-stock angles: 60°, 82°, 90°, 100° and 120°.

Tool Number	Body Diameter	Shank Diameter	Shank Diameter
MM-312-1	1/4"	3/16"	—
MM-312-2	5/16"	1/4"	—
MM-312-3	3/8"	1/4"	—
MM-312-4	7/16"	1/4"	—
MM-312-5	1/2"	1/4"	3/8"
MM-312-6	5/8"	1/4"	3/8"
MM-312-7	5/8"	3/8"	—
MM-312-8	3/4"	3/8"	—
MM-312-9	1"	3/8"	—
MM-312-10	1 1/8"	1/2"	—
MM-312-11	1 1/4"	5/8"	—
MM-312-12	1 1/2"	3/4"	—
MM-312-13	1 3/4"	3/4"	—



## Martin MM-312B Machine Countersinks

MM-312B Machine Countersinks are precision machined from high speed steel and have three flutes designed for fast chip removal. The cutting edges of Martin Countersinks are relieved radially for fast, free cutting and longer tool life.

Standard included in-stock angles: 60°, 82°, 90°, and 100°.

Tool Number	Body Diameter	Shank Diameter	Shank Length
MM-312B-1	1/2"	1/2"	2 1/4"
MM-312B-2	5/8"	1/2"	2 1/4"
MM-312B-3	3/4"	1/2"	2 1/4"
MM-312B-4	7/8"	1/2"	2 1/4"
MM-312B-5	1"	1/2"	2 1/4"

OTHER SIZES AVAILABLE ON REQUEST

# MARTIN MM-324/326/327

## FEMALE-THREADED COUNTERSINKS & COUNTERBORES

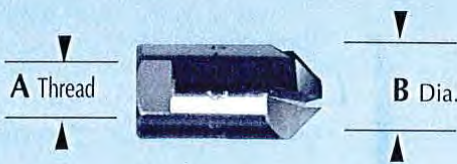

### Martin MM-324 Stop Countersink Cutters

Three-straight flute replaceable pilot cutters with female thread. For replaceable pilots, refer to the MM-311 series.

Standard included in-stock angles: 82° and 100°.

Tool Number	Cutter Diameter	Thread Size	Pilot Hole
MM-324-1	3/8"	1/4"-28	.086
MM-324-2	7/16"	1/4"-28	.086
MM-324-3	1/2"	1/4"-28	.086
MM-324-4	9/16"	1/4"-28	.086
MM-324-5	5/8"	1/4"-28	.086
MM-324-6	3/4"	3/8"-24	.170
MM-324-7	7/8"	3/8"-24	.170
MM-324-8	1"	3/8"-24	.170

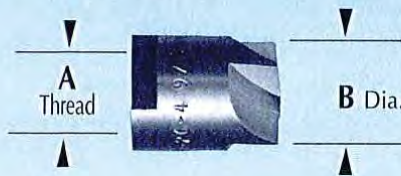

### Martin MM-326 Stop Counterbore Cutters

Four flute spotfacer cutters have .030 corner radii. Other radii furnished on customer request.

For replaceable pilots refer to the MM-311 series.

Tool Number	Cutter Diameter	Female Thread Size	Pilot Hole
MM-326-1	3/8"	1/4"-28	.086
MM-326-2	7/16"	1/4"-28	.086
MM-326-3	1/2"	1/4"-28	.086
MM-326-4	9/16"	1/4"-28	.086
MM-326-5	5/8"	1/4"-28	.086
MM-326-6	11/16"	1/4"-28	.086
MM-326-7	3/4"	3/8"-24	.170
MM-326-8	7/8"	3/8"-24	.170

### Martin MM-327 Replaceable Shaft



Tool Number	"A" Shaft Dia.	"B" Thread Dia.
MM-327-1	1/4"	1/4"-28
MM-327-2	3/8"	3/8"-24

# MARTIN MM-328/329 COUNTERSINK AND SPOTFACER



## Martin MM-328 Straight Shank Countersink with Interchangeable Cutters and Pilots

MM-328 assembly consist of MM-324 Cutter, MM-311 pilot, and MM-327 straight shank. Has collet-type shaft to securely hold replaceable pilot. Standard included in-stock angles: 82° and 100°.

When ordering please specify Part Number, Cutter Angle, Pilot Diameter.  
Example: 1" x 100°, 1.4" Pilot

Tool Number	"B"	"S"	"A"
MM-328-1	3/8"	1/4"	SPECIFY
MM-328-2	7/16"	1/4"	
MM-328-3	1/2"	1/4"	
MM-328-4	9/16"	1/4"	
MM-328-5	5/8"	1/4"	
MM-328-6	3/4"	3/8"	
MM-328-7	7/8"	3/8"	
MM-328-8	1"	3/8"	

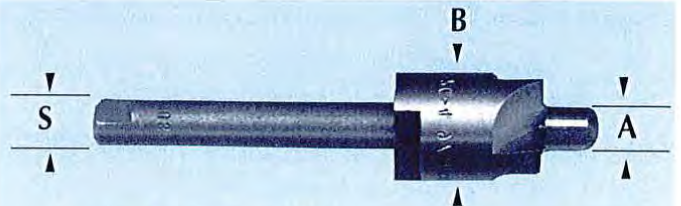

## Martin MM-329 Spotfacer Assembly

MM-329 spotfacer Assembly is designed to offer interchangeable spotfacer and pilot combinations consist of MM-326 Cutter, MM-311 pilot, and MM-327 straight shank.

Furnished with 1/32 corner radii.

When ordering please specify Part Number, and Pilot Diameter.  
Example: MM-326-3 with 7/16" Pilot

Tool Number	"B"	"S"	"A"
MM-329-1	3/8"	1/4"	SPECIFY
MM-329-2	7/16"	1/4"	
MM-329-3	1/2"	1/4"	
MM-329-4	9/16"	1/4"	
MM-329-5	5/8"	1/4"	
MM-329-6	11/16"	3/8"	
MM-329-7	3/4"	3/8"	
MM-329-8	7/8"	3/8"	
MM-329-9	1"	3/8"	

# MARTIN MM-330/331/332 COLLAR CUTTER and REMOVER

## MM-330 HI-SHEAR COLLAR CUTTER

MM-330 Hi-Shear collar remover cutter is a precise tool designed to remove Hi-shear rivet collars without the aid of a micro-stop unit. These cutters are made of high speed tool steel and are ground to proper clearance to insure free cutting. This tool has adjustable internal stop to allow resharpening.



Tool Number	Rivet Size
MM-330-0	1/8"
MM-330-00	5/32"
MM-330-1	3/16"
MM-330-2	1/4"
MM-330-3	5/16"
MM-330-4	3/8"
MM-330-5	7/16"
MM-330-6	1/2"
MM-330-7	9/16"
MM-330-8	5/8"

## MM-331/332 COLLAR REMOVER for HI-LOK TYPE FASTENERS

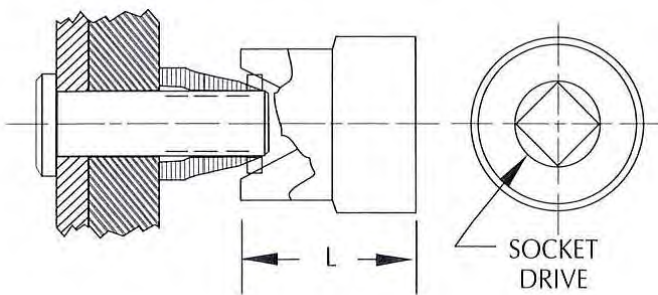

Tool Number	Size	L	D
MM-331-1	5/32"	7/8"	1/2"
MM-331-2	3/16"	7/8"	1/2"
MM-331-3	1/4"	7/8"	11/16"
MM-331-4	5/16"	7/8"	3/4"
MM-331-5	3/8"	1"	7/8"
MM-331-6	7/16"	1 1/16"	15/16"

1/4" Socket Drive



Tool Number	Size	L	D
MM-332-1	5/32"	1 1/2"	1/2"
MM-332-2	3/16"	1 1/2"	1/2"
MM-332-3	1/4"	1 1/2"	11/16"
MM-332-4	5/16"	1 1/2"	3/4"
MM-332-5	3/8"	1 1/2"	7/8"
MM-332-6	7/16"	1 1/2"	15/16"

3/8" Socket Drive

# MARTIN MM-447 DRILL STOPS

## Martin Drill Stops

Used to control drilling depth and protect surfaces from being damaged due to contact with the drill in motion.

### Features:

- Regulates hole depth
- Cushions breakthrough
- Reduces surface marring
- Minimizes drill breakage
- Available in many sizes
- Heat treated to prevent galling during use.



Part Number	Drill Size	Hole Dia.	Color Coded	Part Number	Drill Size	Hole Dia.	Color Coded
MM-447-0	50	073	Black	MM-447-5	12	191	Brass
MM-447-0A	41	097	Copper	MM-447-5A	11	193	Zinc
MM-447-1	40	099	Zinc	MM-447-6	10	196	Brass
MM-447-2	30	130	Copper	MM-447-6A	7	203	Brass
MM-447-2A	28	145	Zinc	MM-447-6B	6	206	Black
MM-447-2B	27	146	Zinc	MM-447-7	1/4	257	Copper
MM-447-3	21	161	Black	MM-447-8	5/16	315	Copper
MM-447-4	20	163	Zinc	MM-447-8A	7/32	221	Copper
MM-447-4A	17	175	Copper	MM-447-8B	9/32	284	Copper
MM-447-4B	16	179	Black				

OTHER SIZES AVAILABLE ON REQUEST, PARTS ARE ALSO MARKED WITH SIZE

# MARTIN MM-701/702/703/704 CARBIDE STOP COUNTERSINK CUTTERS



## Martin MM-701/702 Replaceable Pilot Type

MM-701 and MM-702 Cutters are manufactured with heavy carbide tips for longer tool life. The tips are brazed to a steel body designed to give the necessary impact resistance to prevent breakage. For use in adjustable micro stop countersink units.

When ordering please specify Tool Number plus "Dash" number (i.e. MM-701-1, or MM-702-1).  
Stocked in 100°. Other angles available on request.  
Please refer to MM-311 series for pilots.

### 2-FLUTE

MM-701 Pilot Hole	MM-702 Pilot Hole	"Dash" Number	Body Dia.	Thread Size
5/64"	.086	-1	3/8"	1/4"-28
5/64"	.086	-2	7/16"	1/4"-28
5/64"	.086	-3	1/2"	1/4"-28
1/8"		-3A	1/2"	1/4"-28
1/8"	.086	-4	5/8"	1/4"-28

### 3-FLUTE

MM-701 Pilot Hole	MM-702 Pilot Hole	"Dash" Number	Body Dia.	Thread Size
3/16"	.170	-5	3/4"	3/8"-24
3/16"	.170	-6	7/8"	3/8"-24
3/16"	.170	-7	1"	3/8"-24
3/16"	.170	-8	1 1/8"	3/8"-24
3/16"	.170	-9	1 1/4"	3/8"-24
3/16"	.170	-10	1 3/8"	3/8"-24
3/16"	.170	-11	7/8"	7/16"-20
3/16"	.170	-12	1"	7/16"-20
3/16"	.170	-13	1 1/8"	7/16"-20
3/16"	.170	-14	1 1/4"	7/16"-20
3/16"	.170	-15	1 3/8"	7/16"-20
3/16"	.170	-16	1 1/2"	7/16"-20



## Martin MM-703/704 Straight Flute Replaceable Pilot Type

MM-703 and MM-704 cutters are manufactured from solid carbide for longer tool life. The tips are brazed to a steel body designed to give the necessary impact resistance to prevent breakage. For use in adjustable micro-stop countersink units.

When ordering please specify Tool Number plus "Dash" number (i.e. MM-701-1, or MM-702-1).  
Stocked in 100°. Other angles available on request.  
Please refer to MM-311 series for pilots.

### 2-FLUTE

MM-703 Pilot Hole	MM-704 Pilot Hole	"Dash" Number	Body Dia.	Thread Size
5/64"	.086	-1	3/8"	1/4"-28
5/64"	.086	-2	7/16"	1/4"-28
5/64"	.086	-3	1/2"	1/4"-28
1/8"		-3A	1/2"	1/4"-28
1/8"	.086	-4	5/8"	1/4"-28

### 3-FLUTE

MM-703 Pilot Hole	MM-704 Pilot Hole	"Dash" Number	Body Dia.	Thread Size
3/16"	.170	-5	3/4"	3/8"-24
3/16"	.170	-6	7/8"	3/8"-24
3/16"	.170	-7	1"	3/8"-24
3/16"	.170	-8	1 1/8"	3/8"-24
3/16"	.170	-9	1 1/4"	3/8"-24
3/16"	.170	-10	1 3/8"	3/8"-24
3/16"	.170	-11	7/8"	7/16"-20
3/16"	.170	-12	1"	7/16"-20
3/16"	.170	-13	1 1/8"	7/16"-20
3/16"	.170	-14	1 1/4"	7/16"-20
3/16"	.170	-15	1 3/8"	7/16"-20
3/16"	.170	-16	1 1/2"	7/16"-20



# MARTIN MM-710 INTEGRAL PILOT TYPE

## Martin MM-710 Integral Pilot Type

MM-710 cutters are manufactured with carbide integral pilot and countersink body brazed to a steel shank and precision ground for concentricity.



Tool Number	Dia.	Pilot Range
MM-710-1	3/8"	3/32" to #10
MM-710-2	7/16"	3/32" to 7/32"
MM-710-3	1/2"	1/8" to F
MM-710-4	5/8"	1/8" to 5/16"

### 2-FLUTE

Tool Number	Body Dia.	Thread Size	Pilot Dia.
MM-710-1	3/8"	1/4"-28	SPECIFY
MM-710-2	7/16"	1/4"-28	
MM-710-3	1/2"	1/4"-28	
MM-710-4	5/8"	1/4"-28	

### 3-FLUTE

Tool Number	Body Dia.	Thread Size	Pilot Dia.
MM-710-5	3/4"	3/8"-24	SPECIFY
MM-710-6	7/8"	3/8"-24	
MM-710-7	1"	3/8"-24	
MM-710-8	1 1/8"	3/8"-24	
MM-710-9	1 1/4"	3/8"-24	
MM-710-10	1 3/8"	3/8"-24	
MM-710-11	7/8"	7/16"-20	
MM-710-12	1"	7/16"-20	
MM-710-13	1 1/8"	7/16"-20	
MM-710-14	1 1/4"	7/16"-20	
MM-710-15	1 3/8"	7/16"-20	
MM-710-16	1 1/2"	7/16"-20	

When ordering please specify Part Number, Angle and Pilot Dia. Stocked in 100° only. Other angles available on request.

# MARTIN MM-285/731 PILOTS for SPOTFACERS/COUNTERSINKS

## Martin MM-285 Pilot

For reverse spotfacers and countersinks.



Tool Number	Pilot Hole
MM-285-1	3/32"
MM-285-2	1/8"
MM-285-3	5/32"
MM-285-4	3/16"
MM-285-5	1/4"
MM-285-6	5/16"
MM-285-7	3/8"
MM-285-8	1/2"

## Martin MM-731 Step Pilots

For carbide reverse spotfacers and countersinks.



(Corresponding to the reverse spotfacer or countersink being used.)

Tool Number	Pilot Dia.	Drive Dia.	Length
MM-731-1	1/8"	3/32"	6"
MM-731-2	5/32"	1/8"	6"
MM-731-3	3/16"	5/32"	6"
MM-731-4	1/4"	3/16"	6"
MM-731-5	5/16"	1/4"	6"
MM-731-6	3/16"	5/32"	6"
MM-731-7	1/4"	3/16"	6"
MM-731-8	5/16"	1/4"	6"
MM-731-9	3/8"	5/16"	6"
MM-731-10	1/2"	3/8"	6"
MM-731-11	9/16"	1/2"	6"
MM-731-12	5/16"	1/4"	6"

Tool Number	Pilot Dia.	Drive Dia.	Length
MM-731-13	3/8"	5/16"	6"
MM-731-14	1/2"	3/8"	6"
MM-731-15	3/8"	5/16"	6"
MM-731-16	1/2"	3/8"	6"
MM-731-17	9/16"	1/2"	6"
MM-731-18	1/2"	3/8"	6"
MM-731-19	9/16"	1/2"	6"
MM-731-20	3/4"	5/8"	6"
MM-731-21	7/8"	5/8"	8"
MM-731-22	7/8"	3/4"	8"
MM-731-23	1"	3/4"	8"
MM-731-24	1 3/4"	3/4"	8"

# MARTIN MM-720/730 CARBIDE REVERSE SPOTFACER/COUNTERSINK



## Martin MM-720 Carbide Reverse Spotfacer

Designed for cutting stainless steel and other high tensile strength alloys in confined areas where conventional spotfacing methods cannot be used. Furnished with 1/64" corner radius unless otherwise specified. Maximum dead center diameter 1/32" larger than pilot hole.

1J (1/4" dia.) through 9L (3/4" dia.):

4 Flute solid carbide construction

10J (7/8" dia.) through 18M (2" dia.):

4 Flute carbide tipped construction



## Martin MM-730 Carbide Reverse Countersink

Designed for countersinking harder materials in restricted areas. Stocked in 100° only. Other angles available on request. Maximum dead center diameter 1/32" larger than pilot hole.

1J (1/4" dia.) through 9L (3/4" dia.):

3 Flute solid carbide construction

10J (7/8" dia.) through 12K (1 1/4" dia.):

3 Flute carbide tipped construction

When ordering please specify Tool Number plus "Dash" number (i.e. MM-720-1, or MM-730-1).

For MM-730 please specify countersink angle (i.e. MM-730-1-100°)

### MM-720 and MM-730

"Dash" Number	Body Dia.	Pilot Hole
-1J	1/4"	3/32"
-1K	1/4"	1/8"
-2J	5/16"	3/32"
-2K	5/16"	1/8"
-2L	5/16"	5/32"
-3J	3/8"	1/8"
-3K	3/8"	5/32"
-3L	3/8"	3/16"
-4J	7/16"	1/8"
-4K	7/16"	5/32"
-4L	7/16"	3/16"
-5J	1/2"	5/32"
-5K	1/2"	3/16"
-5L	1/2"	1/4"
-6J	9/16"	5/32"
-6K	9/16"	3/16"
-6L	9/16"	1/4"
-7J	5/8"	3/16"
-7K	5/8"	1/4"
-7L	5/8"	5/16"
-8J	11/16"	3/16"

"Dash" Number	Body Dia.	Pilot Hole
-8K	11/16"	1/4"
-8L	11/16"	5/16"
-9J	3/4"	1/4"
-9K	3/4"	1/4"
-9L	3/4"	3/8"
-9M	13/16"	1/4"
-9N	13/16"	5/16"
-9O	13/16"	3/8"
-10J	7/8"	1/4"
-10K	7/8"	5/16"
-10L	7/8"	3/8"
-10M	15/16"	1/4"
-10N	15/16"	5/16"
-10O	15/16"	3/8"
-11J	1"	5/16"
-11K	1"	3/8"
-11L	1"	1/2"
-11M	1 1/4"	3/8"
-11N	1 1/4"	1/2"
-12J	1 1/4"	3/8"
-12K	1 1/4"	1/2"

### MM-720 only

"Dash" Number	Body Dia.	Pilot Hole
-13J	1 3/8"	3/8"
-13K	1 3/8"	1/2"
-13L	1 3/8"	5/8"
-14J	1 1/2"	3/8"
-14K	1 1/2"	1/2"

"Dash" Number	Body Dia.	Pilot Hole
-14L	1 1/2"	5/8"
-15M	1 5/8"	3/4"
-16M	1 3/4"	3/4"
-17M	1 7/8"	3/4"
-18M	2"	3/4"

To order Pilots for MM-720 and MM-730, please refer to MM-285 and MM-731 Ordering Sheet.

### Martin MM-285 Pilot

For reverse spotfacers and countersinks.



### Martin MM-731 Step Pilot

For carbide reverse spotfacers and countersinks.

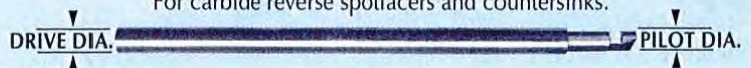

# MARTIN MM-740 STOP COUNTERBORES-MALE THREAD



## Martin MM-740 Carbide Stop Counterbores, Male Thread

A series of carbide tipped cutters engineered to counterbore exotic or extremely abrasive materials and to operate in micro-stop countersink units.

The maximum dead center diameter is 1/32" larger than the pilot hole. We recommend the use of pilots with the pilot head a minimum of 1/32" larger than the shank diameter.

3 Flutes.

All counterbores are supplied with 1/64" corner radius unless otherwise specified.

Tool Number	Body Dia.	Pilot Hole	Thread Size
MM-740-1	3/8"	3/32"	1/4"-28
MM-740-2	7/16"	1/8"	1/4"-28
MM-740-3	1/2"	1/8"	1/4"-28
MM-740-4	9/16"	1/8"	1/4"-28
MM-740-5	5/8"	1/8"	1/4"-28
MM-740-6	11/16"	3/16"	3/8"-24
MM-740-7	3/4"	3/16"	3/8"-24
MM-740-8	13/16"	3/16"	3/8"-24
MM-740-9	7/8"	3/16"	3/8"-24
MM-740-10	15/16"	3/16"	3/8"-24
MM-740-11	1"	3/16"	3/8"-24
MM-740-12	1 1/8"	3/16"	3/8"-24
MM-740-13	1 1/4"	3/16"	3/8"-24
MM-740-14	11/16"	3/16"	7/16"-20
MM-740-15	3/4"	3/16"	7/16"-20
MM-740-16	13/16"	3/16"	7/16"-20
MM-740-17	7/8"	3/16"	7/16"-20
MM-740-18	15/16"	3/16"	7/16"-20
MM-740-19	1"	3/16"	7/16"-20
MM-740-20	1 1/8"	3/16"	7/16"-20
MM-740-21	1 1/4"	3/16"	7/16"-20

To order MM-276 Pilots for MM-740, please refer to MM-276/277 Ordering Sheet.

## Martin MM-276 Counterbore Pilot



# MARTIN MM-750 CARBIDE TIPPED COUNTERBORES



Tool Number	D-Dia.	Pilot Hole	L-Length
MM-750-1	1/4"	3/32"	2 3/8"
MM-750-2	9/32"	3/32"	2 3/8"
MM-750-3	5/16"	3/32"	2 3/8"
MM-750-4	11/32"	3/32"	2 3/8"
MM-750-5	3/8"	3/32"	2 3/8"
MM-750-6	13/32"	1/8"	2 3/4"
MM-750-7	7/16"	1/8"	2 3/4"
MM-750-8	15/32"	1/8"	2 3/4"
MM-750-9	1/2"	1/8"	2 3/4"
MM-750-10	17/32"	1/8"	2 3/4"
MM-750-11	9/16"	1/8"	2 3/4"
MM-750-12	19/32"	1/8"	2 3/4"
MM-750-13	5/8"	1/8"	2 3/4"
MM-750-14	21/32"	3/16"	2 3/4"
MM-750-15	11/16"	3/16"	2 3/4"
MM-750-16	23/32"	3/16"	2 3/4"
MM-750-17	3/4"	3/16"	2 3/4"
MM-750-18	25/32"	3/16"	2 3/4"
MM-750-19	13/16"	3/16"	2 3/4"
MM-750-20	27/32"	3/16"	2 3/4"

Tool Number	D-Dia.	Pilot Hole	L-Length
MM-750-21	7/8"	3/16"	2 3/4"
MM-750-22	29/32"	3/16"	2 3/4"
MM-750-23	15/16"	3/16"	2 3/4"
MM-750-24	31/32"	3/16"	2 3/4"
MM-750-25	1"	3/16"	2 3/4"
MM-750-26	1 1/16"	3/16"	2 3/4"
MM-750-27	1 1/8"	3/16"	2 3/4"
MM-750-28	1 3/16"	3/16"	2 3/4"
MM-750-29	1 1/4"	1/4"	2 3/4"
MM-750-30	1 5/16"	1/4"	2 3/4"
MM-750-31	1 3/8"	1/4"	2 3/4"
MM-750-31B	1 7/16"	1/4"	2 3/4"
MM-750-32	1 1/2"	1/4"	2 3/4"
MM-750-33	1 9/16"	5/16"	3 3/4"
MM-750-34	1 5/8"	5/16"	3 3/4"
MM-750-35	1 11/16"	5/16"	3 3/4"
MM-750-36	1 3/4"	5/16"	3 3/4"
MM-750-37	1 13/16"	5/16"	3 3/4"
MM-750-38	1 7/8"	5/16"	3 3/4"
MM-750-39	1 15/16"	5/16"	3 3/4"
MM-750-40	2"	5/16"	3 3/4"

# MARTIN MM-800 RIVET SHAVER CUTTER

## RIVET SHAVER CUTTERS

are precision made from the finest quality material and have carbide inserts selected to give chatter-free, longer tool life.

The flute configuration in our shaver cutters was specifically designed to give maximum chip clearance and to eliminate the web and dead center. Elimination of the web in the center of the cutter reduces breakage. Elimination of the dead center in the cutter allows for clean rivet shaving to the center, making it possible to shave such rivets as monel, steel and jo-bolts.

The exclusive design of our flute configuration makes it possible to shave rivets faster and better on the automatic riveters.

The Martin Rivet Shaver Cutters are standard and interchangeable with most types now in use.



Exclusive design eliminates web and dead center.



### RESHARPENING

Get the most from your investment in shaver cutters by taking advantage of our resharpening service. Your dull tools will be precision re-ground by skilled experts, and will provide new tool performance.

Model Number	Diameter	Thread 5/16
MM-800-1	5/16	1/4 -28
MM-800-2	3/8	1/4 -28
MM-800-3	7/16	1/4 -28
MM-800-4	1/2	1/4 -28
MM-800-5	9/16	1/4 -28
MM-800-6	5/8	1/4 -28
MM-800-7	3/4	1/4 -28
MM-800-8	7/8	1/4 -28
MM-800-9	1"	1/4 -28

**FASTENERS**

**Wing Nut Fasteners** — Hand operated for use with heavier materials and where more tension is required.



0"-1/2"

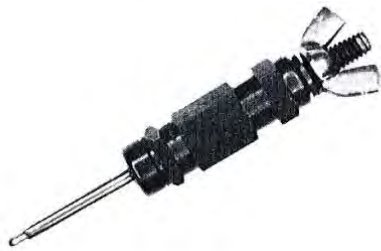

0"-1"

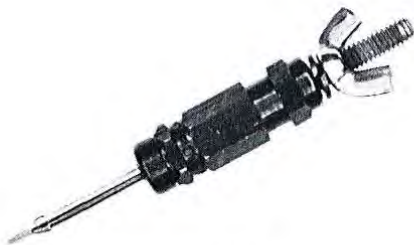

1/2"-1 1/2"

Tool Number	Size	Reference Drill Size	Material Capacity	Color
MM-439WNX-1	3/32"	#40	0"-1/2"	Cadmium
MM-439WNX-2	1/8"	#30	0"-1/2"	Copper
MM-439WNX-3	5/32"	#20	0"-1/2"	Black
MM-439WNX-4	3/16"	#10	0"-1/2"	Brass
MM-439WNX-5	7/32"	#2	0"-1/2"	Cadmium
MM-439WNX-6	1/4"	1/4"	0"-1/2"	Copper
MM-439WNX-7	5/16"	5/16"	0"-1/2"	Black

Tool Number	Size	Reference Drill Size	Material Capacity	Color
MM-439WNXL-1	3/32"	#40	0"-1"	Cadmium
MM-439WNXL-2	1/8"	#30	0"-1"	Copper
MM-439WNXL-3	5/32"	#20	0"-1"	Black
MM-439WNXL-4	3/16"	#10	0"-1"	Brass
MM-439WNXL-5	7/32"	#2	0"-1"	Cadmium
MM-439WNXL-6	1/4"	1/4"	0"-1"	Copper
MM-439WNXL-7	5/16"	5/16"	0"-1"	Black

Tool Number	Size	Reference Drill Size	Material Capacity	Color
MM-439WNXEL-1	3/32"	#40	1/2"-1 1/2"	Cadmium
MM-439WNXEL-2	1/8"	#30	1/2"-1 1/2"	Copper
MM-439WNXEL-3	5/32"	#20	1/2"-1 1/2"	Black
MM-439WNXEL-4	3/16"	#10	1/2"-1 1/2"	Brass
MM-439WNXEL-5	7/32"	#2	1/2"-1 1/2"	Cadmium
MM-439WNXEL-6	1/4"	1/4"	1/2"-1 1/2"	Copper
MM-439WNXEL-7	5/16"	5/16"	1/2"-1 1/2"	Black

**DRILL STOPS**



**M-447** The standard drill stop in the aircraft and industrial field. The spring cushions the break-through and prevents the chuck jaws from marring the work. Greatly reduces drill breakage.

<b>MM-447-0</b>	# 50	1-5/16"
<b>MM-447-1</b>	# 40	1-5/16"
<b>MM-447-2</b>	# 30	1-5/16"
<b>MM-447-3</b>	# 21	1-1/2"
<b>MM-447-4</b>	# 20	1-1/2"
<b>MM-447-5</b>	# 12	1-1/2"
<b>MM-447-6</b>	# 10	1-1/2"
<b>MM-447-7</b>	1/4"	2-1/8"
<b>MM-447-8</b>	5/16"	2-1/8"

**FASTENER PLIERS**



**MM-448** Forged steel fastener pliers for ease of operation and safety. Plier permits full in line travel of the plunger. Allowing easier insertion and removal of fastener. Undercut seat in plier jaw keeps fastener from flying out when under compression. For use with all plunger and open spring type fasteners.



**Countersink Cutters  
and Accessories**

**DIFFERENT STYLES**

**For Aluminum and Dural**



**Two Flutes  
Removable Pilot**



**Two Flutes  
Integral Pilot**



**Two Flutes  
Integral Pilot  
Drill & Countersink**

**For Stainless Steel and Titanium**



**Three Flutes  
Removable Pilot**



**Three Flutes  
Integral Pilot**

Our HSS cutters are precision ground with perfect cutting edges for chatterless countersinking, and specially heat treated for efficient cutting. Easily resharpened.



**Cobalt and carbide tips available upon request.**

**MM-TH-7  
T-handle**

**Installation and Removal Ratchet screwdriver**



**Features:**

**Quick Release  
Adjustable Handle 45° or 90°**



**Ratchet Mechanism  
Easy and convenient bits store**



**Includes:**

**Phillips Insert Bits:**



**Screwdriver bits  
#1, #2, #3**

**Slotted Insert Bits:**



**Screwdriver bits  
#5, #6, #7**

# Coming Soon.....



## Screwdriver bits.....

## And.....



## Cleco Fasteners.....